



Alfa Laval SMP-BC Mixproof Valve

The Proven Mixproof Range

Concept

SMP-BC is a hygienic pneumatic seat valve, designed for safety and leak detection when two different products flow through only one valve. The valve is often used as a part in CIP return lines or other systems not experiencing pressure spikes offering leakage detection for greater safety.

Working principle

SMP-BC is remote-controlled by means of compressed air. The valve is a normally closed (NC) valve. The valve is fitted with two small pneumatic normally open (NO) valves, a detecting valve and a CIP-valve. The valve plug (the upper plug in a change-over valve) has two seals, forming a leakage chamber under atmospheric pressure between them. Leaking product flows into the leakage chamber and is discharged through the detecting valve. SMP-BC can be cleaned by CIP by supplying compressed air to the actuator (see fig. 1). During cleaning of the valve, flow pattern against the closing direction of the valve plug makes SMP-BC insensitive to water hammer.



TECHNICAL DATA

Max. product pressure (depending on valve specifications): 1000 kPa (10 bar).
 Min. product pressure: Full vacuum.
 Temperature range: -10°C to +140°C (EPDM).
 Air pressure: 500 to 800 kPa (5 to 8 bar).

PHYSICAL DATA

Product wetted steel parts: 1.4401 (316L).
 External surface finish Semi-bright (blasted)
 Internal surface finish Bright (polished), Ra < 1.6 µm
 Other steel parts: 1.4301 (304).
 Product wetted seals: EPDM.
 Other seals: NBR

Valve body combination

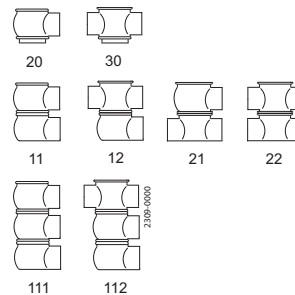

Type 20 and 30 body versions are on request available in following configurations:

- Tee welded on lower port in 0 or 90 deg. version
- Bend welded on lower port in 0, 90, 180 or 270 deg. version

The three body version is on request available in following configurations:

- Type 121, 122, 211, 212, 221 & 222

Standard design

SMP-BC is available in two versions, as a shut-off valve with one valve body or as a change-over valve with three valve bodies (sizes DN125-150 only as shut-off valve).

The valve bodies and the external actuator are clamped together. SMP-BC is fitted with one detecting valve and one CIP-valve. The seals and the lip seal can be serviced after removing the actuator.

It is recommended, due to the valve size and weight, to use supporting equipment, handling and installing the valve. Guidelines are given in the instruction manual (IM70771). Alfa Laval is not able to supply the recommended supporting equipment.

Options

- A. Male parts or clamp liners in accordance with required standard.
- B. Control and Indication: IndiTop, ThinkTop or ThinkTop Basic.
- C. Actuator with stronger spring.
- D. Larger actuator for valve sizes 38-51 mm/DN40-50.
- E. CIP installation kits.
- F. Other valve body combinations.
- G. Surface roughness, product wetted parts: $Ra \leq 0.8 \mu m$.
- H. Product wetted seals of NBR or FPM.
- I. Service tools for actuator.
- J. Tool for plug seals (Necessary for changing the seals).

Note!

For further details, see also instruction IM 70771.

Air consumption (litres free air) for one stroke

Size	38-51 mm	63.5101.6 mm	DN 125-150	DN 125-150
	DN 40-50	DN 65100	DN 125-150	DN 125-150
Stop valve	0.2 x air pressure (bar)	0.7 x air pressure (bar)	1.5 x air pressure (bar)	2.2 x air pressure (bar)
Actuator function	NC	NC	NC	
Stop valve			3.6 x air pressure (bar)	2.9 x air pressure (bar)
Actuator function			NC (Support air for closing)	(Support air for opening)
Change-over valve	0.2 x air pressure (bar)	0.7 x air pressure (bar)		
Actuator function	NC	NC		

Operation/cleaning

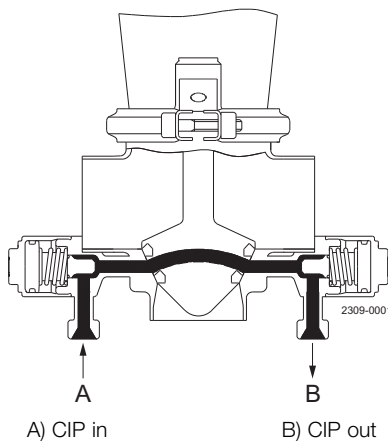

a. Closed shut-off valve:
Cleaning of the leakage chamber.

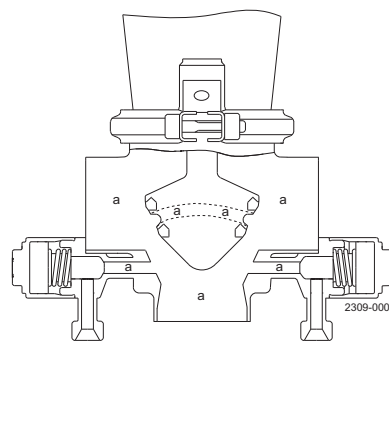

b. Open shut-off valve
a. Cleaning of the valve body and the leakage chamber.

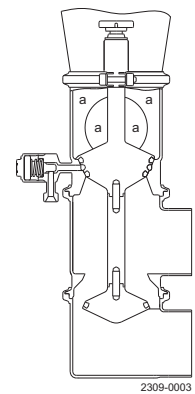

c. Closed change-over valve
a. Cleaning of the upper valve body.

Pressure drop/capacity diagrams

Shut-off valve:

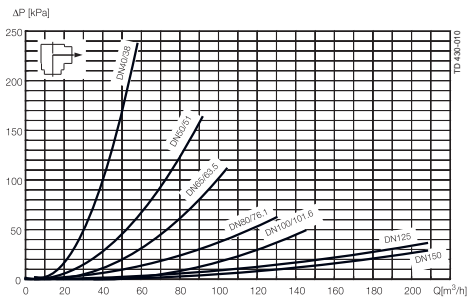
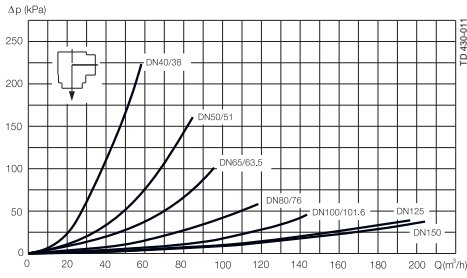
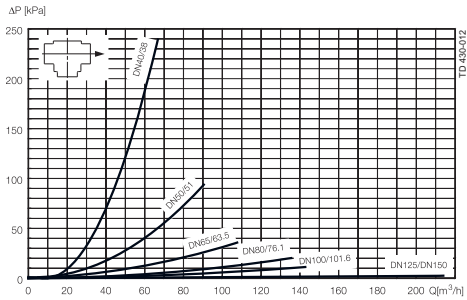

Leakage chamber, pressure drop and flow velocity.

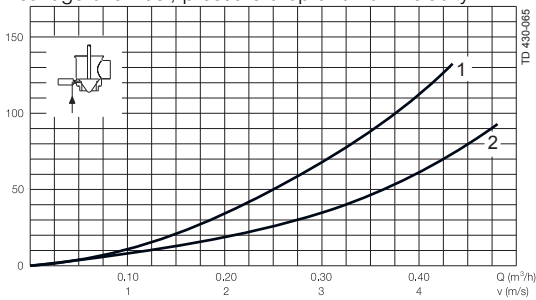

- 1) CIP/detecting valve $\varnothing 27$
- 2) CIP/detecting valve $\varnothing 32$

Change-over valve:

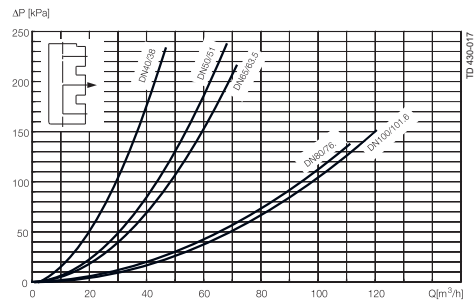
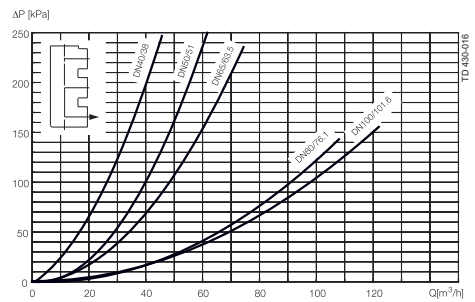
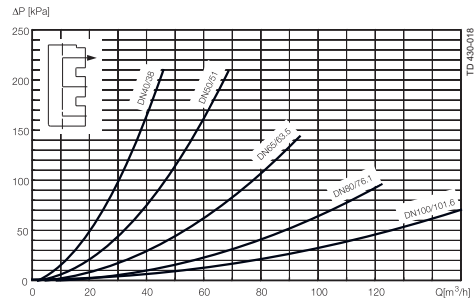
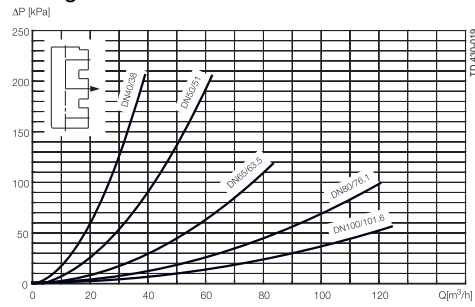

Note! For the diagrams the following applies:
Medium: Water (20°C).

Measurement: In accordance with VDI 2173.

Max pressure difference/support air pressure diagrams

Upper plug max. product pressure without leakage, as a function of support air:

ø89 Actuator

Support air P_{air} [bar]

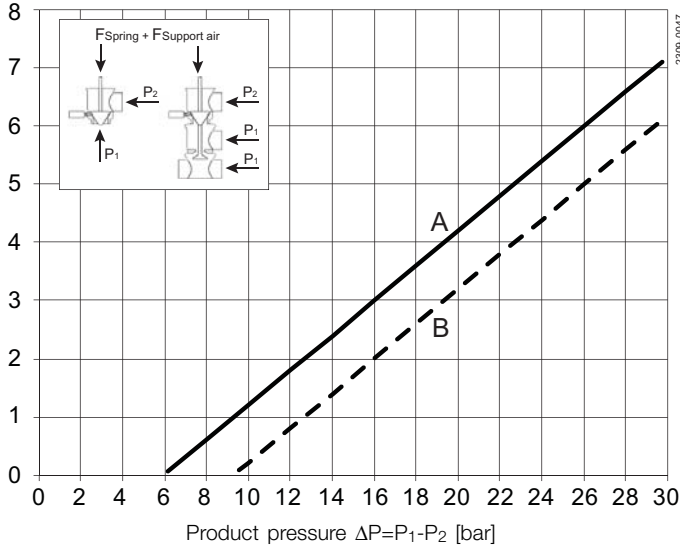

- A. ø89 std. spring; DN40/DN50; ISO38/ISO51
- B. ø89 strong. spring; DN40/DN50; ISO38/ISO51

ø133 actuator with standard spring

Support air P_{air} [bar]

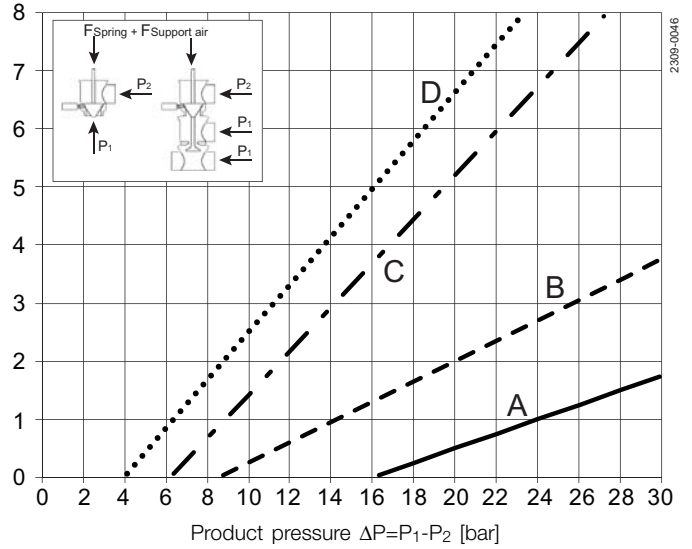

- A. DN40/DN50; ISO38/ISO51
- B. DN65; ISO63.5
- C. DN80; ISO76.1
- D. DN100; ISO101.6

ø133 actuator with strong spring

Support air P_{air} [bar]

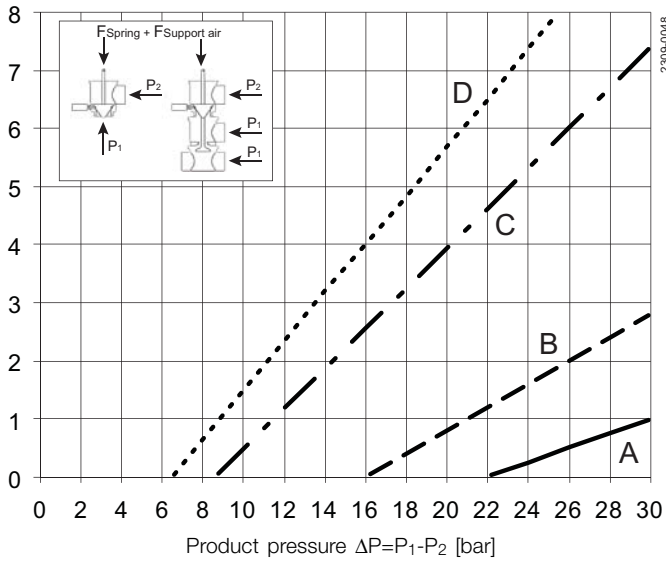

- A. DN40/DN50; ISO38/ISO51
- B. DN65; ISO63.5
- C. DN80; ISO76.1
- D. DN100; ISO101.6

ø199 actuator

Support air P_{air} [bar]

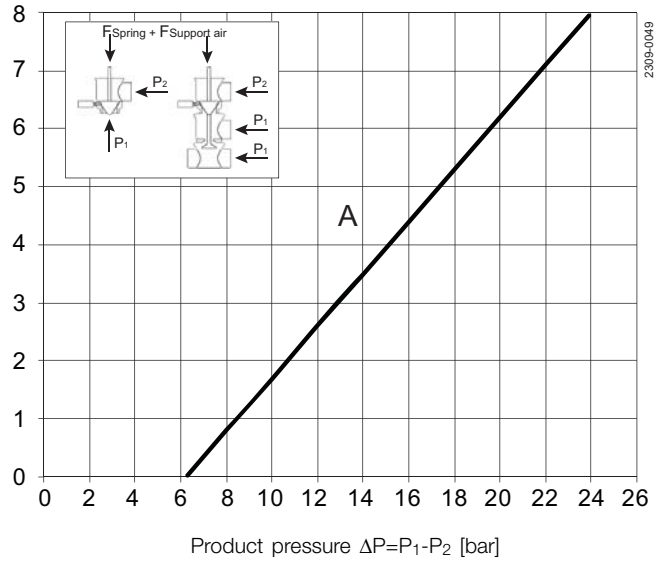

- A. DN125; DN150

Upper plug max. product pressure against which the valve can open, as a function of air pressure:

ø89 Actuator with standard spring

Air Pressure P_{air} [bar]

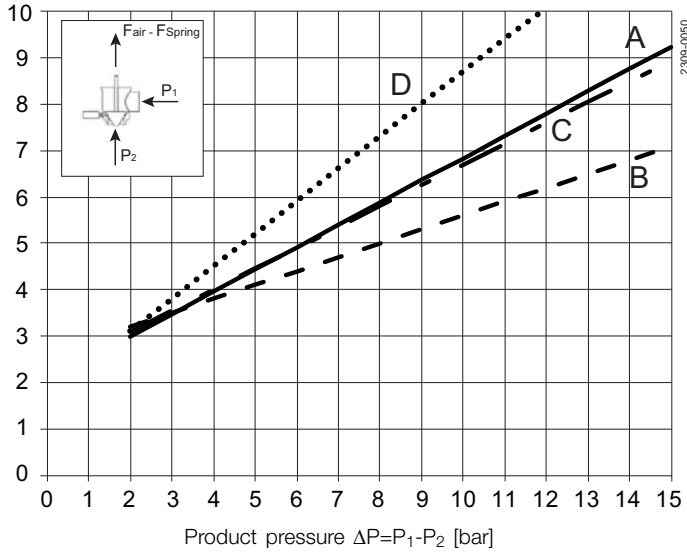

- A. DN40/DN50/DN80; ISO38/ISO51/76.1
- B. DN65; ISO63.5
- C. DN80; ISO76.1
- D. DN100; ISO101.6

ø89 actuator with strong spring

Air Pressure P_{air} [bar]

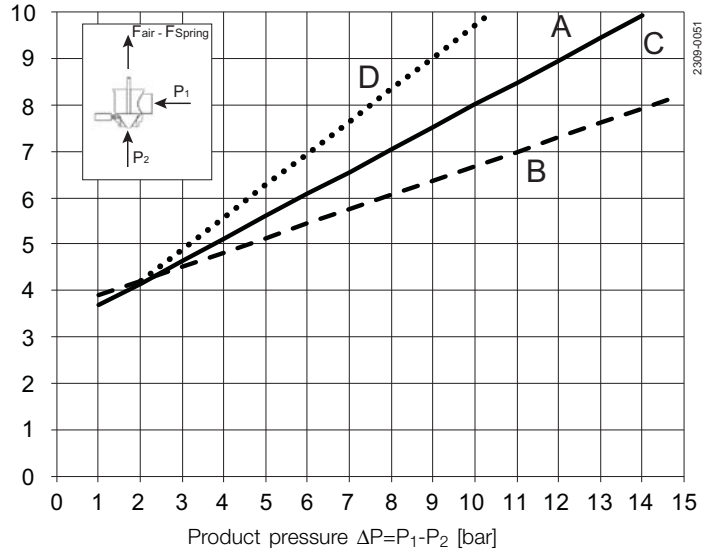

- A. DN40/DN50; ISO38/ISO51
- B. DN65; ISO63.5
- C. DN80; ISO76.1
- D. DN100; ISO101.6

ø133 actuator with standard spring

Air Pressure P_{air} [bar]

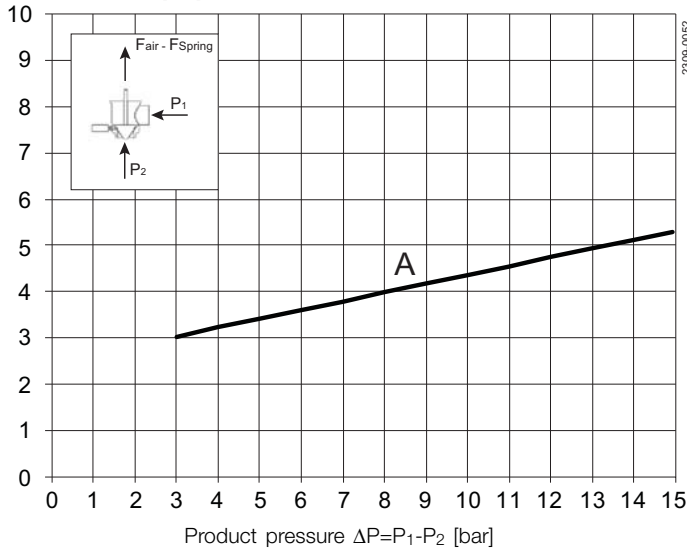

- A. DN40/DN50; ISO38/ISO51

ø133 actuator with strong spring

Air Pressure P_{air} [bar]

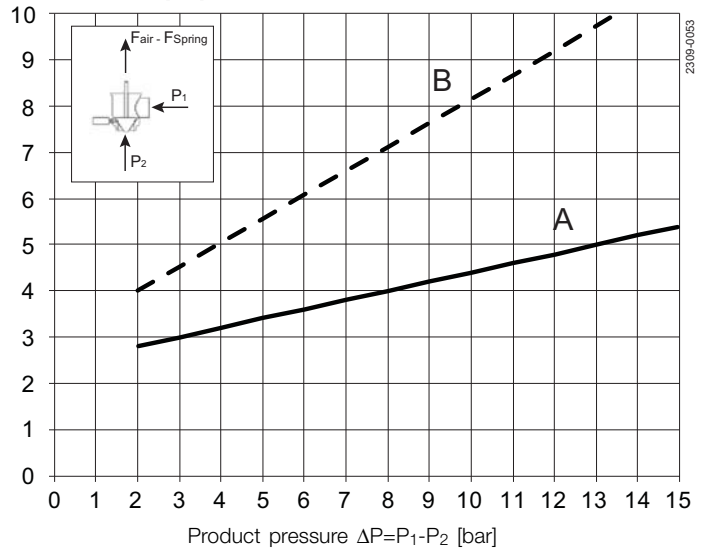

- A. DN40/DN50; ISO38/ISO51
- B. DN125; DN150

Note! If actuator is supported by air on spring side; max allowable pressure is 300 kPa (3 bar)

Upper plug (change over). Max. product pressure against which the valve can open, as a function of air pressure:

ø89 Actuator with standard spring

Air pressure P_{air} [bar]

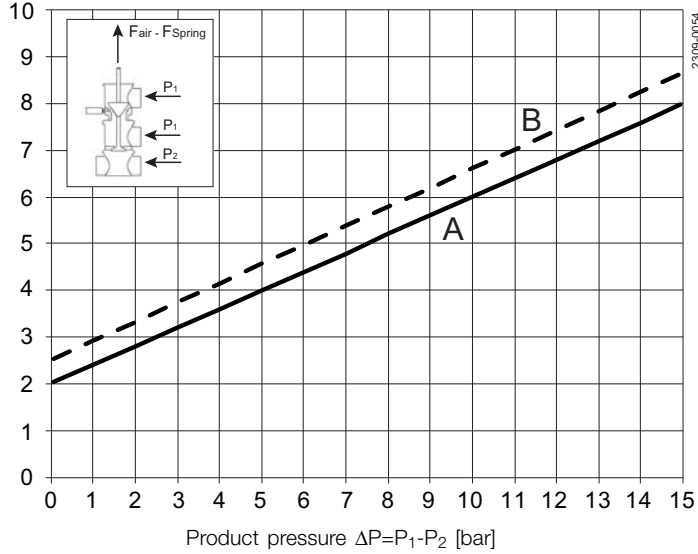

- A. DN40; ISO38
- B. DN50; ISO51

ø89 actuator with strong spring

Air pressure P_{air} [bar]

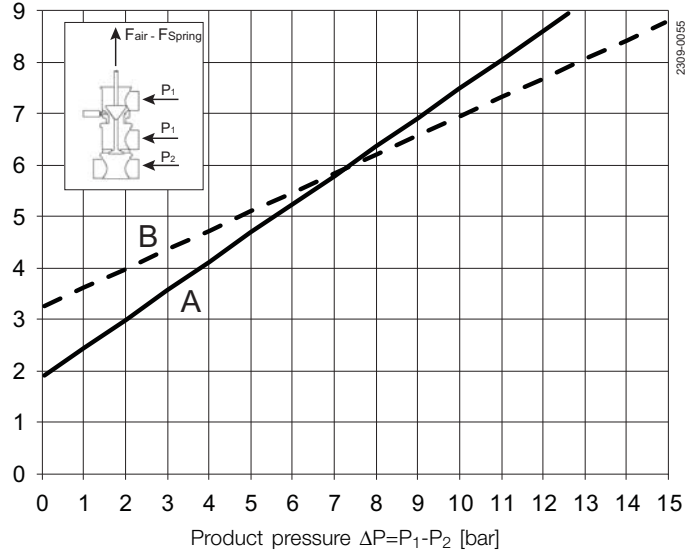

- A. DN40; ISO38
- B. DN50; ISO51

ø133 actuator with standard spring

Air pressure P_{air} [bar]

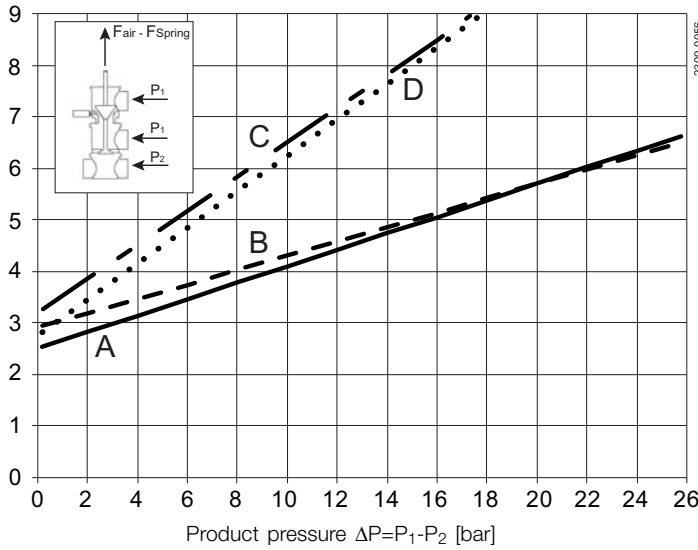

- A. DN40; ISO38
- B. DN50/65; ISO51/ISO63.5
- C. DN80; ISO76.1
- D. DN100; ISO101.6

ø133 actuator with strong spring

Air pressure P_{air} [bar]

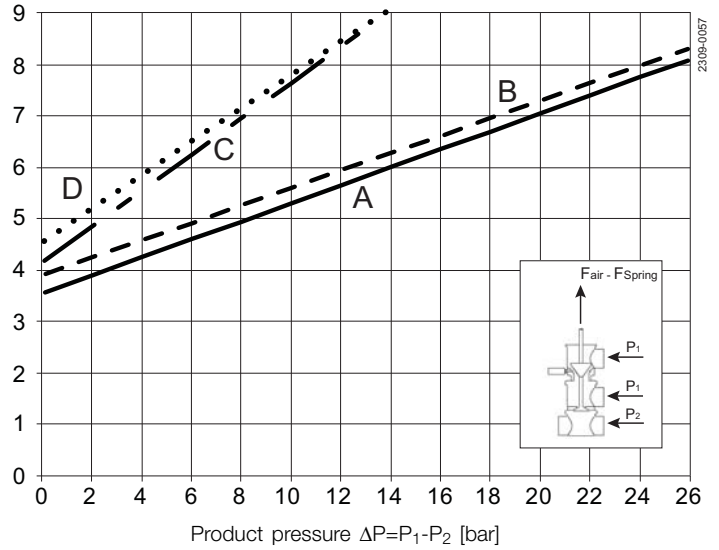

- A. DN40; ISO38
- B. DN50/65; ISO51/ISO63.5
- C. DN80; ISO76.1
- D. DN100; ISO101.6

Upper plug (change over). Max. product pressure against which the valve can open, as a function of support air:

ø89 Actuator with standard spring

Support air P_{air} [bar]

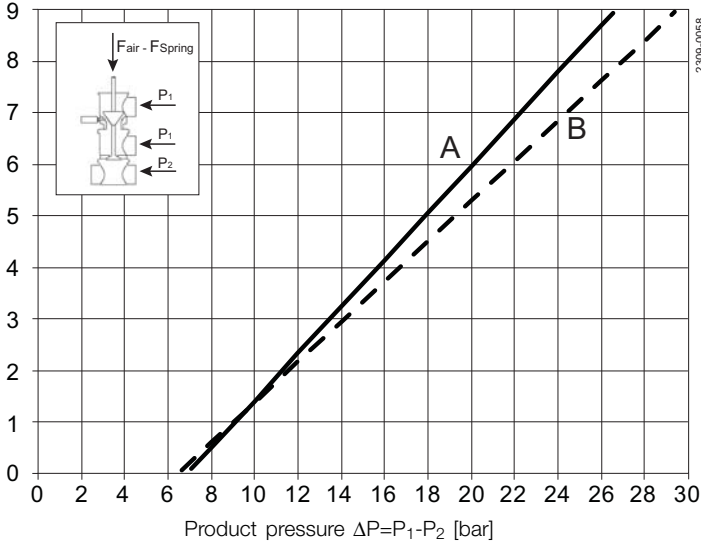

- A. DN40; ISO38
- B. DN50; ISO51

ø89 actuator with strong spring

Support air P_{air} [bar]

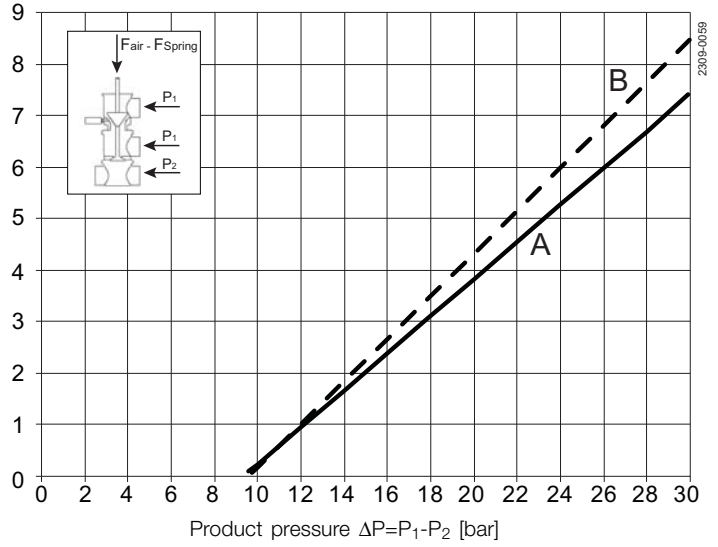

- A. DN40; ISO38
- B. DN50; ISO51

ø133 actuator with standard spring

Support air P_{air} [bar]

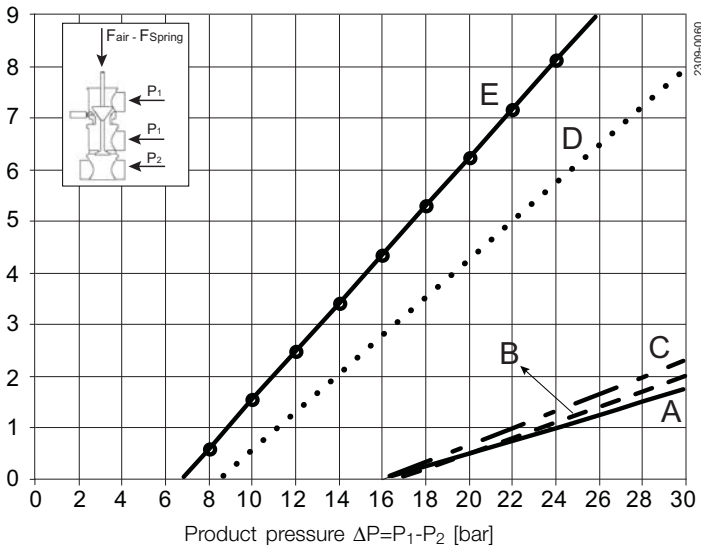

- A. DN40; ISO38
- B. DN50; ISO51
- C. DN65; ISO63.5
- D. DN80; ISO76.1
- E. DN100; ISO101.6

ø133 actuator with strong spring

Support air P_{air} [bar]

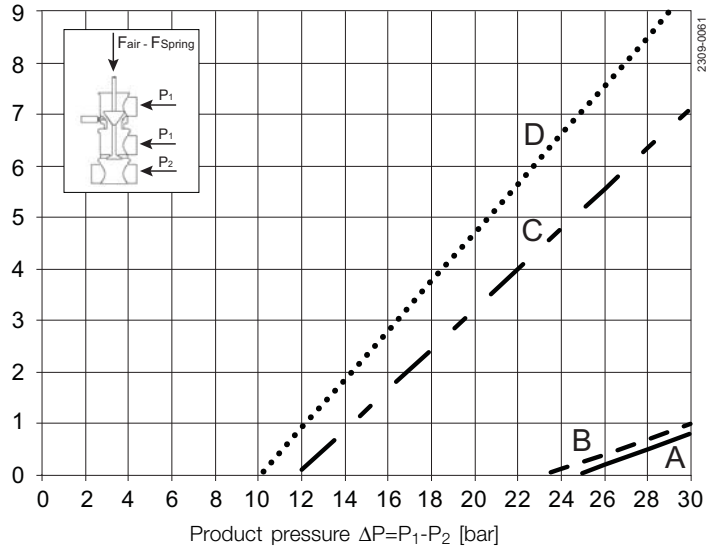

- A. DN40/DN50; ISO38/ISO51
- B. DN65; ISO63.5
- C. DN80; ISO76.1
- D. DN100; ISO101.6

Note! If actuator is supported by air on spring side; max allowable pressure is 300 kPa (3 bar)

CIP/detecting valves. Max. product pressure without leakage, as a function of air pressure:

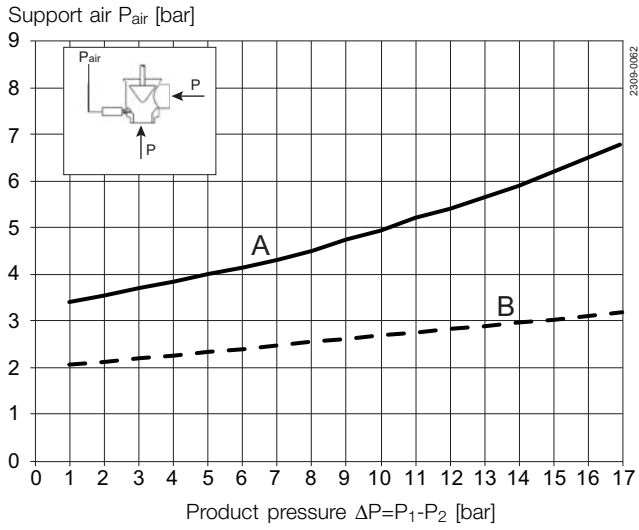

- A. CIP valve $\varnothing 27$
- B. CIP valve $\varnothing 32$

Max. CIP pressure in leakage chamber without leakage to product area, as a function of product pressure.

ø89 Actuator with standard spring

Product pressure $\Delta P = P_1 - P_2$ [bar]

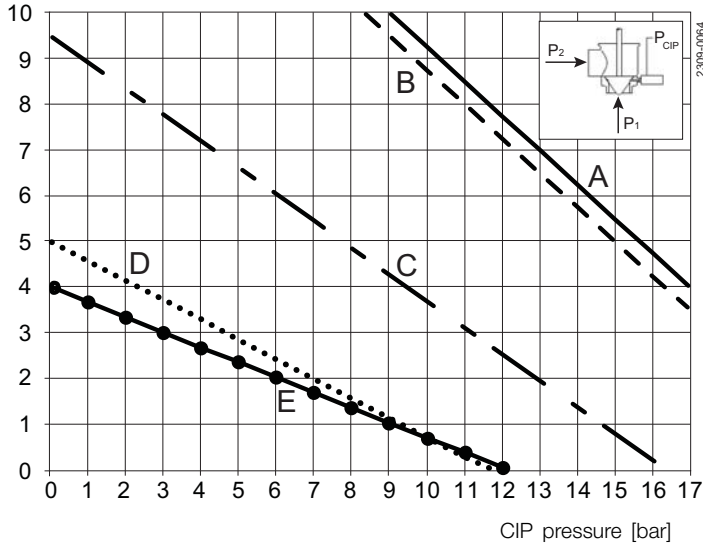

- A. DN40; ISO38
- B. DN50; ISO51
- C. DN65; ISO63.5
- D. DN80; ISO76.1
- E. DN100; ISO101.6

ø89 actuator with strong spring

Product pressure $\Delta P = P_1 - P_2$ [bar]

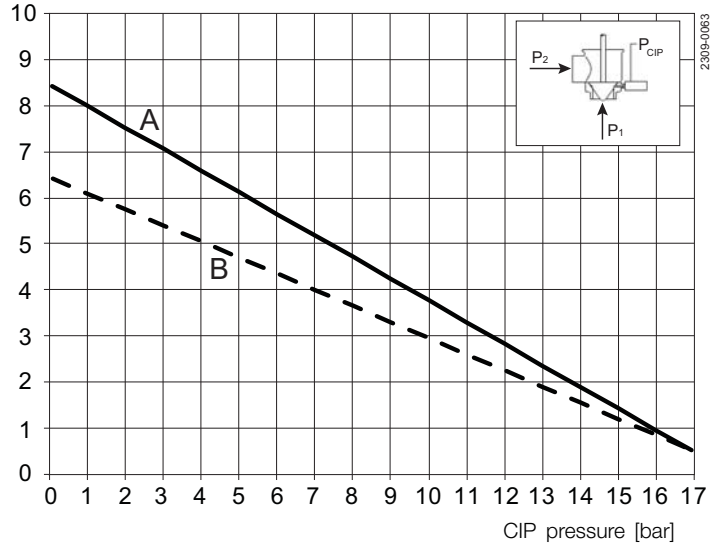

- A. DN80; ISO76.1
- B. DN100; ISO101.6

ø133 actuator with standard spring

Product pressure $\Delta P = P_1 - P_2$ [bar]

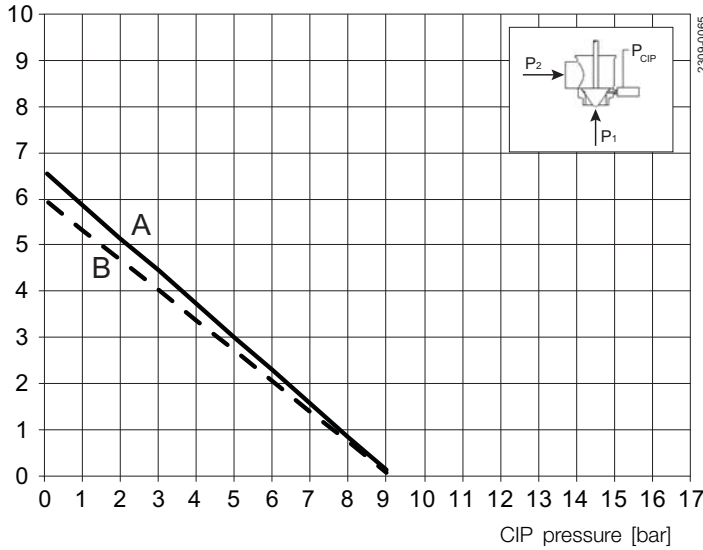

- A. DN40; ISO38
- B. DN50; ISO51

ø133 actuator with strong spring

Product pressure $\Delta P = P_1 - P_2$ [bar]

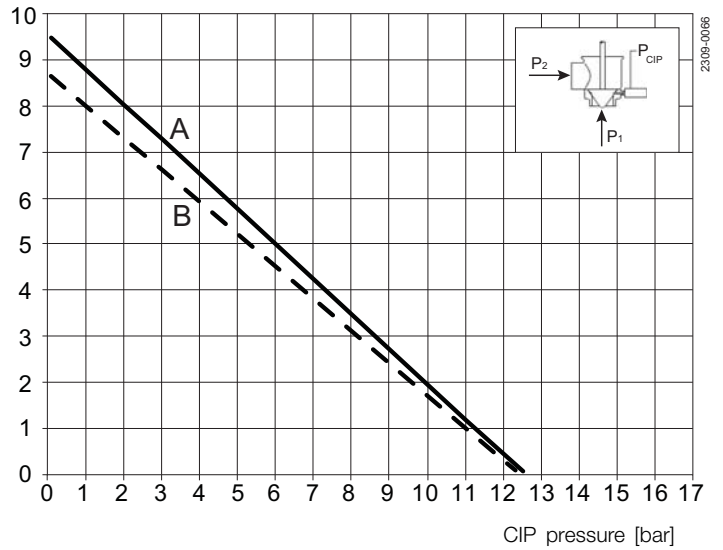

- A. DN40; ISO38
- B. DN50; ISO51

Note! If actuator is supported by air on spring side; max allowable pressure is 300 kPa (3 bar)

Dimensions

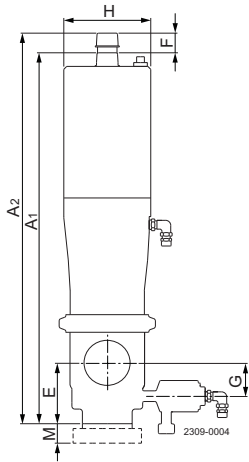

a. Shut-off valve.

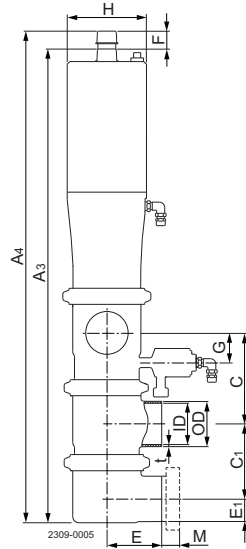

b. Divert valve.

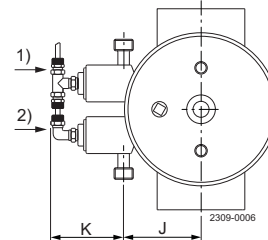

1) CIP valve

2) Detecting valve

c. Top view

Dimensions (mm)

Size	38	51	63.5	76.1	101.6	40	50	65	80	100	125	150
	mm	mm	mm	mm	mm	DN	DN	DN	DN	DN	DN	DN
A ₁	345	355	433	455	527	343	354	430	456	526	535	584
A ₂	370	380	458	487	559	368	379	455	488	558	580	629
A ₃	485.8	505.8	616.2	651.1	751.8	485	506	616	667	752		
A ₄	510.8	530.8	648.2	683.1	783.8	510	531	641	699	784		
C	90	102	124	129	157	90	102	124	134	157		
C ₁	80	84	108	115	150	80	84	108	120.5	150		
OD	38.1	50.8	63.5	76.1	101.6	41	53	70	85	104	129	154
ID	34.9	47.6	60.3	72.1	97.6	38	50	66	81	100	125	150
t	1.6	1.6	1.6	2.0	2.0	1.5	1.5	2.0	2.0	2.0	2.0	2.0
E	49.5	61.5	82.3	87.3	133.5	49.5	61.5	82.3	87.3	133.5	150	150
E ₁	20.5	26.8	33.2	39.1	51.8	22	28	36	43.5	53		
F	25	25	32	32	32	25	25	32	32	32	49	49
G	27	33.3	39.7	45.6	58.3	28.5	34.5	42.5	50	59.5	72	84.5
H	89	89	133	133	133	89	89	133	133	133	199	199
J	46.7	46.7	57	66.6	84.3	46.7	46.7	57	66.6	84.3	99.5	99.5
K	63	63	63	63	63	63	63	63	63	63	58.5	58.5
M/ISO clamp	21	21	21	21	21							
M/ISO male	21	21	21	21	21							
M/DIN male						22	23	25	25	30	46	50
M/SMS male	20	20	24	24	35							
M/BS male	22	22	22	22	27							
Weight (kg)												
Stop valve	6.0	6.3	12.8	13.3	16.6	6.0	6.3	12.8	14.0	16.6	43.4	44.5
Weight (kg)												
Change-over valve	7.7	8.1	15.0	17.0	23.0	7.7	8.1	15.0	18.0	23.0		

Air Connections Compressed air:

R 1/8" (BSP), internal thread.

CIP connection:

R 3/8" (BSP), external thread.

Leakage connection:

R 3/8" (BSP), external thread.

Caution, opening/closing time:

Opening/closing time will be affected by the following:

- The air supply (air pressure).
- The length and dimensions of the air hoses.
- Number of valves connected to the same air hose.
- Use of single solenoid valve for serial connected air actuator functions.
- Product pressure.

Alfa Laval reserves the right to change specifications without prior notification.

How to contact Alfa Laval

Contact details for all countries are continually updated on our website. Please visit www.alfalaval.com to access the information direct.