



Alfa Laval Unique SSV Standard

Single seat valves

Introduction

The Alfa Laval Unique SSV Standard is a versatile, reliable pneumatic single seat valve with a single contact surface between the plug and the seat to minimize the risk of contamination.

Its compact, modular and hygienic design meets the highest process demands in terms of hygiene and safety. It is built on the well-proven Alfa Laval Unique SSV platform. Few moving parts ensure easy maintenance, high reliability and low total cost of ownership. A wide range of optional features enables customization to specific process requirements.

Application

This Unique SSV Standard is designed for use in a broad range of hygienic applications across the dairy, food, beverage, brewery and many other industries.

Benefits

- Exceptional valve hygiene and durability
- Superior cleanability – smooth inner valve body without crevices
- Extended seal life due to the defined seal compression
- Enhanced product safety due to the static seal leak detection
- Protection against full vacuum due to the double lip seal

Standard design

The Unique SSV Standard is available in a one- or two-body configuration, with easy-to-configure valve bodies, plugs, actuator and clamp rings. The valve can be configured as a shutoff valve with two working ports or as a changeover valve with up to five ports.

To ensure flexibility, the valve seat that sits between the two bodies in the changeover version is provided for assembly. The valve seals are optimized for durability and long service life through a defined compression design. The actuator is connected to the valve body using a yoke, and all components are assembled with clamp rings.

The valve can also be fitted with the Alfa Laval ThinkTop V50 and V70 for sensing and control of the valve.

Using the Alfa Laval Anytime configurator, it is easy to customize to meet virtually any process requirement.

Working principle

The Alfa Laval Unique SSV Standard is operated by means of compressed air from a remote location. The actuator smooths operation and protects process lines against pressure peaks, while directing or diverting fluids. The valve can be controlled using an Alfa Laval ThinkTop®.

Certificates

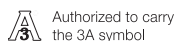

TECHNICAL DATA

Temperature	
Temperature range	-10°C to +140°C (EPDM)

Pressure	
Max. product pressure	1000 kPa (10 bar)
Min. product pressure	Full vacuum
Air pressure	500 to 700 kPa (5 to 7 bar)

Valve Body Combinations

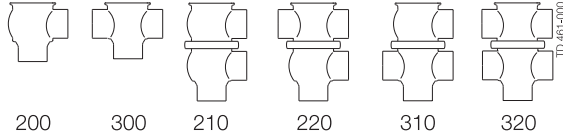

Actuator function

- Pneumatic downward movement, spring return.
- Pneumatic upward movement, spring return.
- Pneumatic upward and downward movement (A/A).

PHYSICAL DATA

Materials	
Product wetted steel parts:	1.4404 (316L)
Other steel parts:	1.4301 (304)
External surface finish:	Semi-bright (blasted)
Internal surface finish:	Bright (polished), Ra < 0.8 µm
Product wetted seals:	EPDM
Other seals:	NBR

Options

- A. Male parts or clamp liners in accordance with required standard.
- B. Control and Indication: IndiTop, ThinkTop or ThinkTop Basic.
- C. Product wetted seals in HNBR or FPM.
- D. Plug seals HNBR, FPM or TR2 plug (floating PTFE design).
- E. External surface finish bright.

Note!

For further details, see instruction ESE00202.

Other valves in the same basic design

The Unique SSV valve range includes several purpose built valves. Below are some of the valve models available, though please use the Alfa Laval Anytime configurator for full access to all models and options.

- Reverse acting valve.
- Long stroke valve.
- Manually operated valve.
- Tank Outlet valve.
- Two Step valve.
- Tangential valve.

Semi-Maintainable actuator comes with 5 year warranty

Dimensions (mm)

Nominal size	Inch tubes						DIN tubes					
	DN/OD						DN					
	25	38	51	63.5	76.1	101.6	25	40	50	65	80	100
A ₁	313	314	363	389	422	467	315	315	364	389	426	470
A ₂	328	334	388	414	452	497	330	335	389	414	456	500
A ₃	360	374.3	436	475	521	591	367	379	439.6	481	533	596
A ₄	372	391	458	497	548	618	379	396	462	503	560	623
A ₁ High pressure	350	350	391	417	535	579	354	353	393	423	539	580
A ₂ High pressure	364	370	416	442	563	608	368	373	418	448	567	610
A ₃ High pressure	396	411	464	503	633	703	401	414	467	509	645	706
A ₄ High pressure	408	428	486	525	658	728	401	414	467	509	670	732
C	47.8	60.8	73.8	86.3	98.9	123.6	52	64	76	92	107	126
OD	25	38	51	63.5	76.1	101.6	29	41	53	70	85	104
ID	21.8	34.8	47.8	60.3	72.9	97.6	26	38	50	66	81	100
t	1.6	1.6	1.6	1.6	1.6	2	1.5	1.5	1.5	2	2	2
E ₁	50	49.5	61	81	86	119	50	49.5	61	78	86	120
E ₂	50	49.5	61	81	86	119	50	49.5	61	78	86	120
F ₁	15	20	25	25	30	30	15	20	25	25	30	30
F ₁ High pressure	14	20	25	25	29	29	14	20	25	25	29	29
F ₂	12	17	22	22	27	27	12	17	22	22	27	27
F ₂ High pressure	12	17	22	22	26	26	-	-	-	-	26	26
H	85	85	115	115	157.5	157.5	85	85	115	115	157.5	157.5
H High pressure	115	115	157.5	157.5	157.5	157.5	115	115	157.5	157.5	157.5	157.5
M/ISO clamp	21	21	21	21	21	21	-	-	-	-	-	-
M/DIN clamp	-	-	-	-	-	-	21	21	21	28	28	28
M/DIN male	-	-	-	-	-	-	22	22	23	25	25	30
M/SMS male	20	20	20	24	24	35	-	-	-	-	-	-
Weight (kg)												
Stop valve:	3.1	3.3	5.5	6.5	11.3	13.6	3.2	3.4	5.5	6.6	11.8	13.6
Change-over valve	3.9	4.2	7.1	8.5	14	18	4.1	4.5	7.2	8.8	14.9	17.9
Stop Valve: High pressure	4.7	4.8	9.5	10.0	9.8	14.2	4.8	4.9	9.5	10.1	10.2	14.2
Change-over valve: High pressure	4.9	5.1	10.1	10.8	10.9	16.5	5.1	5.3	10.1	11.1	11.8	16.4

For exact high pressure actuator dimension (A and F) - please refer to information in Anytime configurator

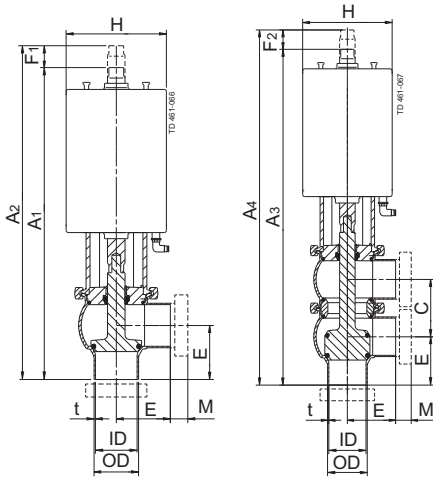

Shut-off valve

Change-over valve

Please note!

Opening/closing time will be effected by the following:

- The air supply (air pressure).
- The length and dimensions of the air hoses.
- Number of valves connected to the same air hose.
- Use of single solenoid valve for serial connected air actuator functions.
- Product pressure.

Air Connections Compressed air:

R 1/8" (BSP), internal thread.

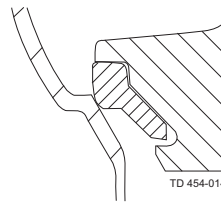

PTFE plug seal (TR2)

Replaceable elastomer plug seal

Air consumption (litres free air) for one stroke

Size	DN25-40	DN50-65	DN80100
	DN/OD 25-38 mm	DN/OD 51-63.5 mm	DN/OD 76.1101.6 mm
NO and NC	0.2 x air pressure [bar]	0.5 x air pressure [bar]	1.3 x air pressure [bar]
A/A	0.5 x air pressure [bar]	1.1 x air pressure [bar]	2.7 x air pressure [bar]

Pressure drop/capacity diagrams

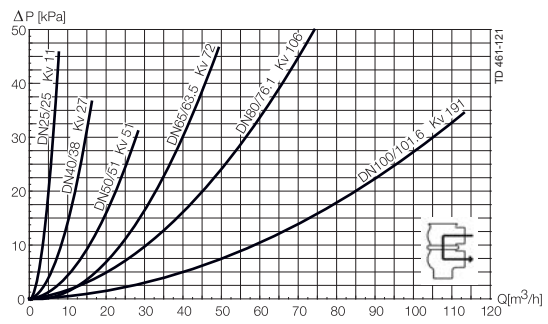
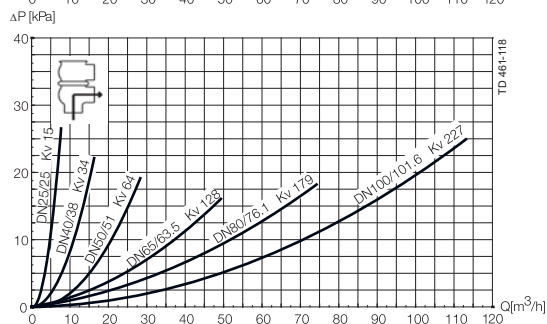
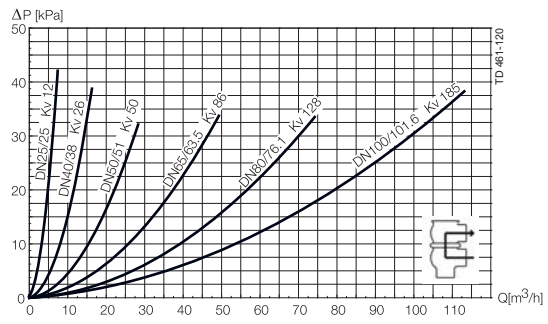
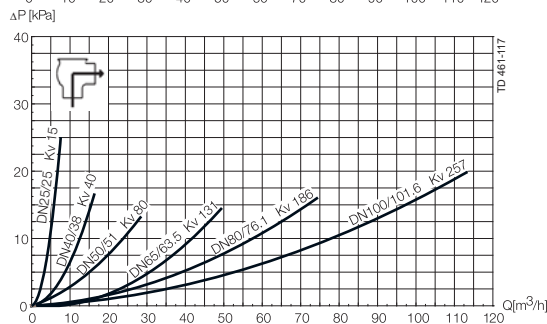
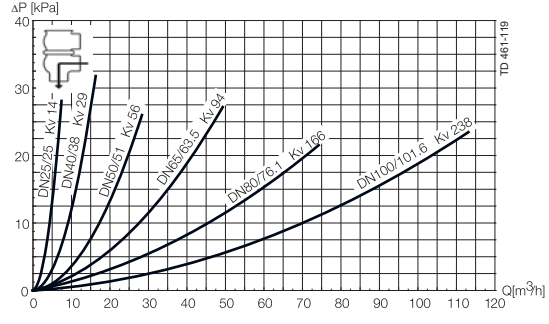
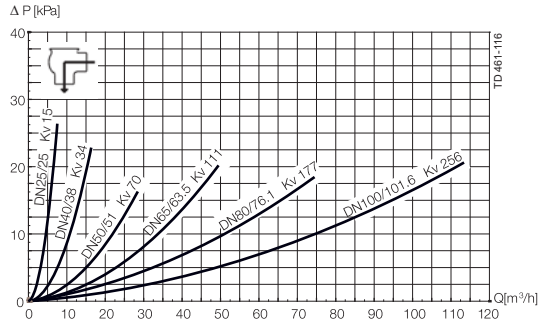

Note!

For the diagrams the following applies:

Medium: Water (20°C)

Measurement: In accordance with VDI2173

Pressure drop can also be calculated in Anytime configurator.

Pressure drop can also be calculated with the following formula:

$$Q = K_v \times \sqrt{\Delta p}$$

Where

Q = Flow in m³/h.

K_v = m³/h at a pressure drop of 1 bar (see table above).

Δ p = Pressure drop in bar over the valve.

How to calculate the pressure drop for an ISO 2.5" shut-off valve if the flow is 40 m³/h 2.5" shut-off valve, where K_v = 111 (See table above).

$$Q = K_v \times \sqrt{\Delta p}$$

$$40 = 111 \times \sqrt{\Delta p}$$

$$\Delta p = \left(\frac{40}{111}\right)^2 = 0.13 \text{ bar}$$

(This is approx. the same pressure drop by reading the y-axis above)

Pressure data for Unique Single Seat Valve standard

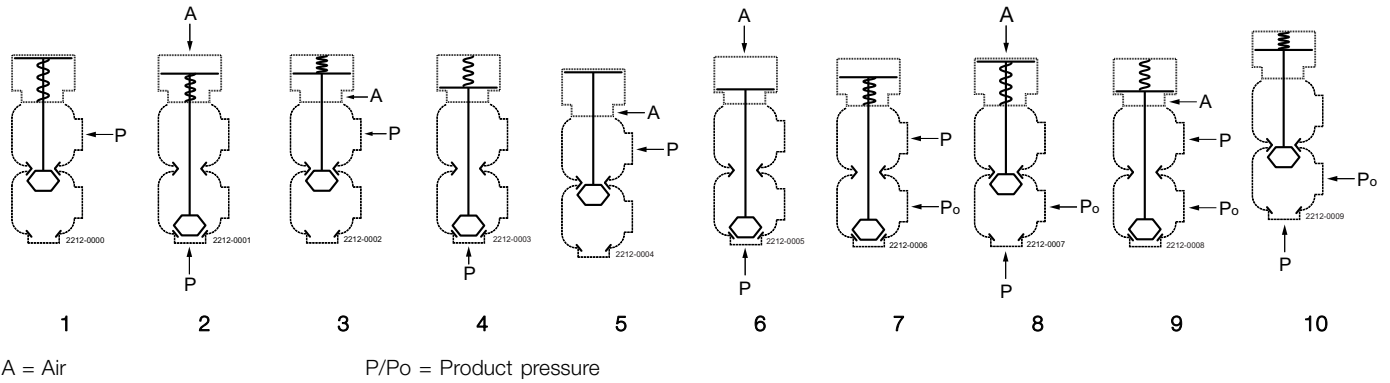

Table 1 - Shut-off and Change-over valves			Max. pressure in bar without leakage at the valve seat					
Actuator / Valve body combination and direction of pressure	Air pressure (bar)	Plug position	Valve size					
			DN 25 DN/OD 25 mm	DN 40 DN/OD 38 mm	DN50 DN/OD 51 mm	DN 65 DN/OD 63.5 mm	DN 80 DN/OD 76.1 mm	DN 100 DN/OD 101.6 mm
1		NO	10.0	8.2	8.4	4.5	6.8	4.4
	5		9.2	4.4	5.9	3.4	4.4	2.9
2	6	NO	10.0	7.6	9.6	5.6	7.2	4.8
	7		10.0	10.0	10.0	7.8	10.0	6.7
3	5	NC	10.0	5.7	6.8	3.7	4.7	3.0
	6		10.0	9.8	10.0	6.1	7.7	5.0
4	7	NC	10.0	10.0	10.0	8.5	10.0	6.9
	5		10.0	6.3	7.2	4.2	6.4	4.2
5	5	A/A	10.0	10.0	10.0	10.0	10.0	9.4
	6		10.0	10.0	10.0	10.0	10.0	10.0
6	7	A/A	10.0	10.0	10.0	10.0	10.0	10.0
	5		10.0	10.0	10.0	10.0	10.0	9.1
	6		10.0	10.0	10.0	10.0	10.0	10.0
	7		10.0	10.0	10.0	10.0	10.0	10.0

Table 2 - Shut-off and Change-over valves			Max. pressure in bar against which the valve can open					
Actuator / Valve body combination and direction of pressure	Air pressure (bar)	Plug position	Valve size					
			DN 25 DN/OD 25 mm	DN 40 DN/OD 38 mm	DN50 DN/OD 51 mm	DN 65 DN/OD 63.5 mm	DN 80 DN/OD 76.1 mm	DN 100 DN/OD 101.6 mm
7		NO	10.0	10.0	10.0	7.4	9.7	6.3
	5		10.0	7.8	10.0	6.1	7.1	4.7
8	6	NO	10.0	10.0	10.0	8.3	9.9	6.6
	7		10.0	10.0	10.0	10.0	10.0	8.5
9	5	NC	10.0	10.0	10.0	6.6	7.5	4.9
	6		10.0	10.0	10.0	9.0	10.0	6.9
10	7	NC	10.0	10.0	10.0	10.0	10.0	8.8
			10.0	9.7	10.0	6.8	9.1	6.1

Table 3 - Shut-off and Change-over valves with high pressure actuator option			Max. pressure in bar without leakage at the valve seat					
Actuator / Valve body combination and direction of pressure	Air pressure (bar)	Plug position	Valve size					
			DN 25 DN/OD 25 mm	DN 40 DN/OD 38 mm	DN50 DN/OD 51 mm	DN 65 DN/OD 63.5 mm	DN 80 DN/OD 76.1 mm	DN 100 DN/OD 101.6 mm
1		NO	10.0	10.0	10.0	10.0	-	-
2	6	NO	10.0	10.0	10.0	10.0	-	-
3	6	NC	10.0	10.0	10.0	10.0	5.0	3.0
4		NC	10.0	10.0	10.0	9.6	10.0	7.0

Alfa Laval reserves the right to change specifications without prior notification.

How to contact Alfa Laval

Contact details for all countries are continually updated on our website. Please visit www.alfalaval.com to access the information direct.